

Series RE-04



Technical details

Temperature range	-10°C ... +70°C
Medium	Filtered, oil-free and dried compressed air according to ISO 8573-1:2010, Class 7:2:4, instrument air, free of aggressive additives. Alternatively the pressure dew point must be at least 10°C below lowest occurring ambient temperature.
Materials	Body: Al (anodized), seals: NBR
Protection	IP 65 according to EN 60529



Manifold system with integrated electrical connection including LED, manual override and built-in circuit protection. Double solenoid valves and 5/3-way valves require 2 stations on the manifold. The above order code covers only the manifold. The valves and the multi-pin plug with cable must be ordered separately. The valve terminal is delivered pre-assembled and function-tested. If not specified with the order, valve configuration is as follows: Valves are mounted according to their order number, starting with high numbers on the side of the multi-pin, ending with low numbers on the opposite side, followed by blind plates (if ordered).

Order code

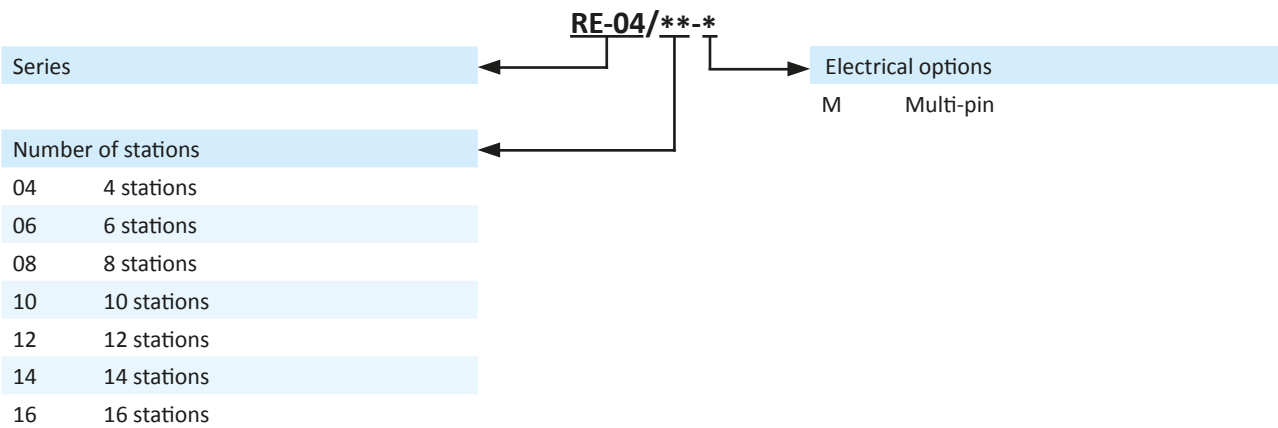

Electrical options

Multi-pin

The 19-pin multi plug (see page 7-04) has to be ordered separately.

Pin	Function	Cable, 8-pin	Cable, 16-pin	Pin	Function	Cable, 8-pin	Cable, 16-pin
1	valve 1	black 1	black 1	11	valve 10	-	black 10
2	valve 2	black 2	black 2	12	PE	green/ yellow	green/ yellow
3	valve 3	black 3	black 3	13	valve 11	-	black 11
4	valve 4	black 4	black 4	14	valve 12	-	black 12
5	valve 5	black 5	black 5	15	valve 13	-	black 13
6	GND	black 9	black 9	16	valve 14	-	black 14
7	valve 6	black 6	black 6	17	valve 15	-	black 15
8	valve 7	black 7	black 7	18	valve 16	-	black 16
9	valve 8	black 8	black 8	19	GND	-	black 18
10	valve 9	-	black 17				

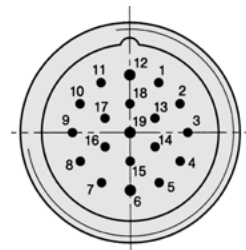

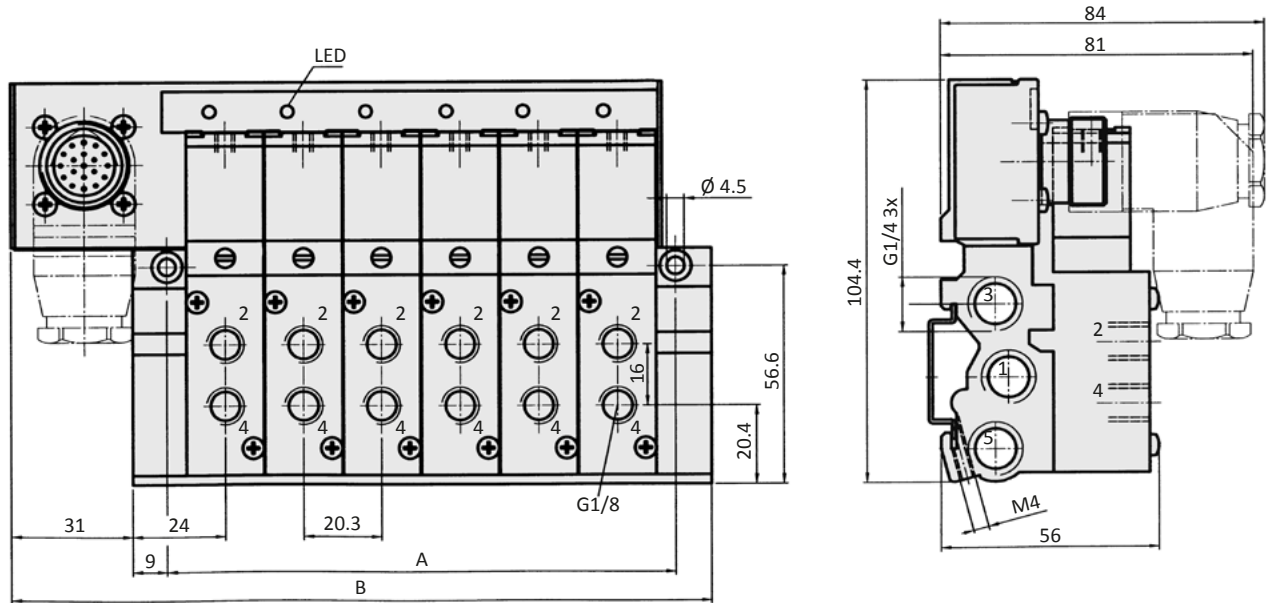
Dimensions

- 1 = pressure inlet
- 2,4 = outlets
- 3,5 = exhausts

Model-no.:	A	B	Weight without valves (kg)
RE-04/04-M	90.9	140	0.51
RE-04/06-M	131.5	180.6	0.72
RE-04/08-M	172.1	221.2	0.93
RE-04/10-M	212.7	261.8	1.14
RE-04/12-M	253.3	302.4	1.35
RE-04/14-M	293.9	343	1.56
RE-04/16-M	334.5	383.6	1.77

Series RE-04

Technical details

Outlets	G1/8
Nominal size	4 mm
Temperature range	-10°C ... +70°C
Medium	Filtered, oil-free and dried compressed air according to ISO 8573-1:2010, Class 7:2:4, instrument air, free of aggressive additives. Alternatively the pressure dew point must be at least 10°C below lowest occurring ambient temperature.
Materials	Body: Al (anodized), plastic, seals: NBR and POM, inner parts: Al, stainless steel and brass
Nominal voltage	24 V DC, ± 10%
Power consumption	2 W
Protection	IP 65 according to EN 60529



Electrically operated spool valve. The manual override is detent and is operated by screwdriver.

5/2-way valves

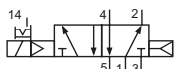

MF-04-510-HN-412
5/2-way, single solenoid, air spring return

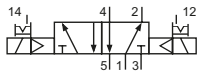

MF-24-520-HN-412
5/2-way, double solenoid

5/3-way valves

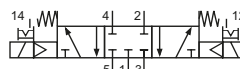

MF-24-530-HN-412
5/3-way, center position closed

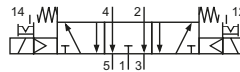

MF-24-533-HN-412
5/3-way, center position exhausted

Technical data

Model-no.:	MF-04-510-HN-412	MF-24-520-HN-412	MF-24-530-HN-412	MF-24-533-HN-412
Required space	1 station	2 stations	2 stations	2 stations
Operating pressure (bar)	2.5...8	2.5...8	3...8	3...8
Pilot pressure (bar)	2.5...8	2.5...8	3...8	3...8
Flow rate (NI/min)	360	360	360	360
Response time (ms) at 6 bar	on: 13 off: 16	on: 11 off: 11	on: 15 off: 22	on: 15 off: 22
Weight (kg)	0.112	0.230	0.232	0.232

Accessories

Model-no.:	RE-04-DT
	Pressure dividing plug



Model-no.:	28-ST-RE-10x-yy
	19-pin multi plug, straight



x = 3 3 m cable
x = 7 7 m cable
yy = 8 up to 8 stations
yy = 16 up to 16 stations

Model-no.:	RE-04-V-EP
	Blind plate



Model-no.:	28-ST-RE-11x-yy
	19-pin multi plug, elbow



x = 3 3 m cable
x = 7 7 m cable
yy = 8 up to 8 stations
yy = 16 up to 16 stations